

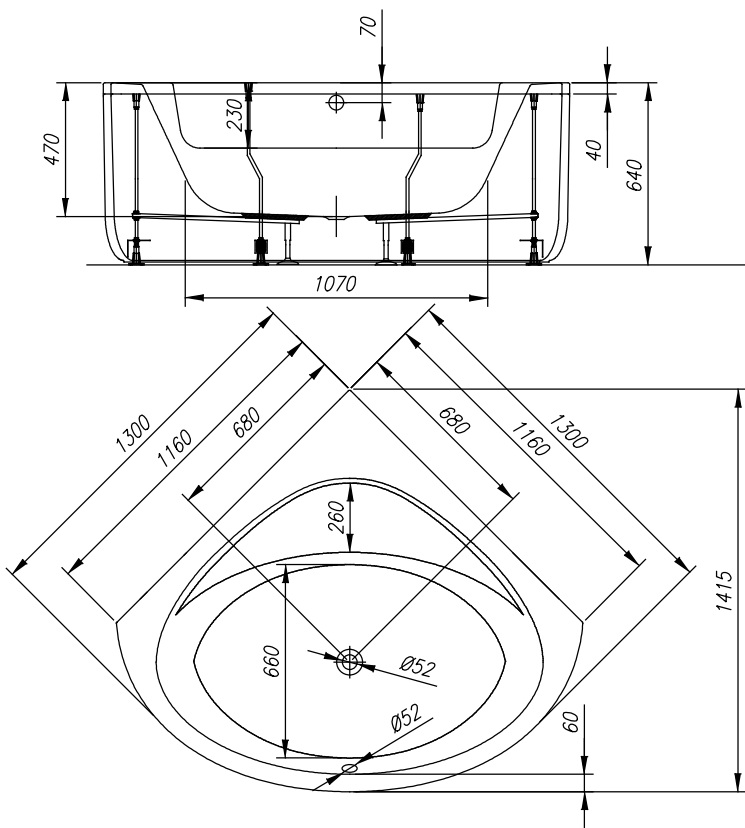

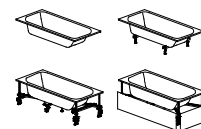

Dolores 130x130

PREDINSTALACIJA
PREINSTALLATION
PREINSTALLATION
VORINSTALLATION



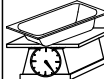

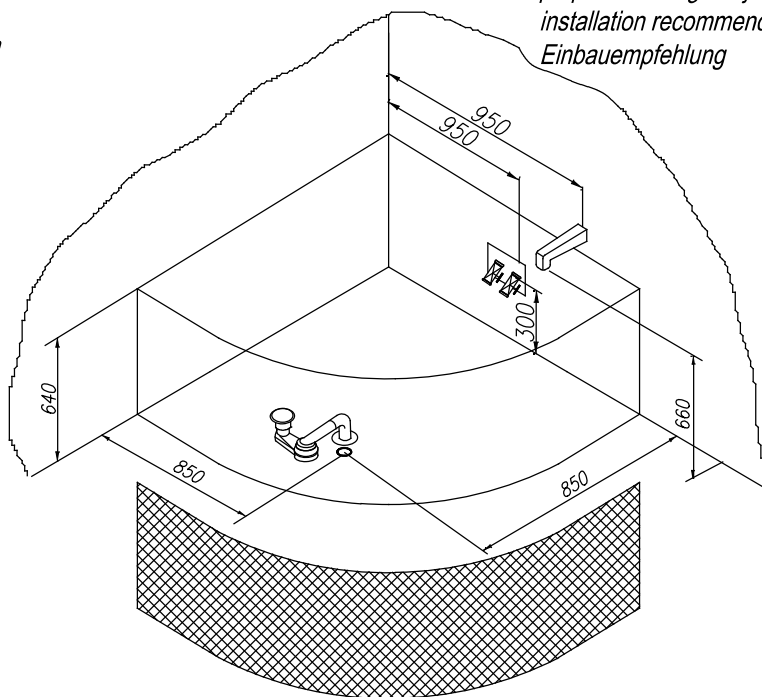

 240 L	VOLUMEN VOLUMEN VOLUME VOLUMEN	 26 kg	TEŽA TEŽINA WEIGHT GEWICHT	 375 kg	MAX. OBREMENITEV MAX. OBTEREČENJE MAX. LOAD MAX. BELASTUNG	 260 kg/m²	OBREMENITEV TAL OBTEREČENJE PODA FLOOR LOAD BODENBELASTUNG
--	---	--	---	--	---	--	---

- Priklop tople in hladne vode 1/2", min 0,2 Mpa, max 0,4 Mpa
- Priključak tople i hladne vode 1/2", min 0,2 Mpa, max 0,4 Mpa
- Connection of hot and cold water 1/2", min 0.2Mpa, max 0.4Mpa
- Anschluss Warm- und Kaltwasser 1/2", min 0,2 Mpa, max 0,4 Mpa
- Prostor za odtok Ø 50 mm
- Mjesto za odtok Ø 50 mm
- Drain spot Ø 50mm
- Abflussplatz Ø 50 mm
- Opcija-obloga
- Opcija-obloga
- Panel - option
- Möglichkeit - Schürze

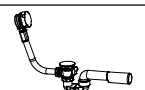
priporočilo za vgradnjo
preporuka za ugradnju
installation recommendation
Einbauempfehlung



Priporočena prelivna garnitura Preporuka prelivne garniture Recommended overflow set Vorgeschlagene Überlaufgarnitur	 PAL 650		
kopalna kad brez oblog - navodilo za vgradnjo Kada bez obloge - upute za ugradnju Bathtub without panel - installation instructions Badewanne ohne Schürze - Einbauanleitung	 Nr. MK 02	Opcija podnožja za kade brez obloge Varianta postolja za kade bez obloge Option of the built-in bathtub base Möglichkeit des Sockels für die Badewannen ohne Schürze	 Nr. MK 06 1001 / B
Kopalna kad z oblogo - navodilo za vgradnjo Kada s oblogom - upute za ugradnju Bathtub with panel - installation instructions Badewanne mit Schürze - Einbauanleitung	 Nr. MK 01	Opcija podnožja za kade z oblogo Varianta postolja za kade sa oblogom Option of the bathtub base with panel Möglichkeit des Sockels für die Badewannen mit Schürze	 Nr. MK 17 CKM 120-150



- MEŠALNI VENTIL TOPLA/HLADNA
- VENTIL ZA MIEŠANJE TOPLO/HLADNO
- MIXING VALVE HOT/COLD
- MISCHVENTIL WARM/KALT



- PREKLOPNIK ROČNA PRHA/IZLIV
- PREKIDAČ ZA RUČNI TUŠ/IZLJEV
- HAND SHOWER/SPOUT SELECTOR SWITCH
- SCHALTER FÜR HANDBRAUSE/AUSLAUF

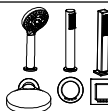

- ROČNA PRHA
- RUČNI TUŠ
- HAND SHOWER
- HANDBRAUSE



- IZLIV
- IZLJEVNIK
- SPOUT
- AUSLAUF



- IZLIV NA PRELIVNI GARNITURI
- IZLJEV NA PRELJEVNOM SETU
- SPOUT ON THE OVERFLOW SET
- AUSLAUF AN DER ÜBERLAUF GARNITUR

- OPCIJA ENOROČNA ARMATURA GEYSER
- OPCIJA JEDNORUČNA ARMATURA GEYSER
- OPTION ONE HAND FITTING GEYSER
- MÖGLICHKEIT EINWEG-ARMATUR GEYSER

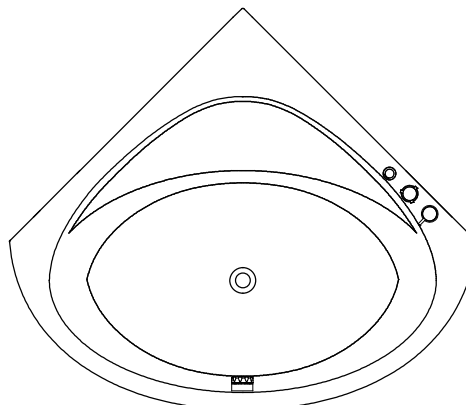
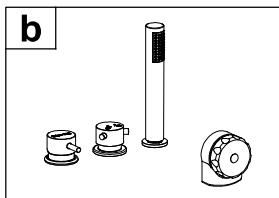

- OPCIJA ENOROČNA ARMATURA RAINDROP
- OPCIJA JEDNORUČNA ARMATURA RAINDROP
- OPTION ONE HAND FITTING RAINDROP
- MÖGLICHKEIT EINWEG-ARMATUR RAINDROP

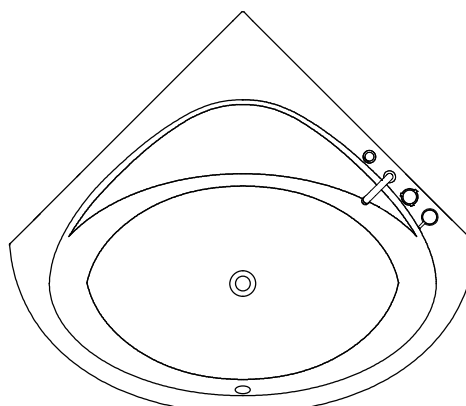
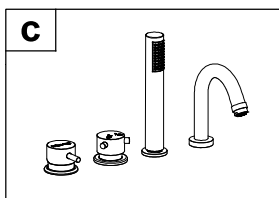

- OPCIJA ENOROČNA ARMATURA STREAM (CHR / BLACK)
- OPCIJA JEDNORUČNA ARMATURA STREAM (CHR / BLACK)
- OPTION ONE HAND FITTING STREAM (CHR / BLACK)
- MÖGLICHKEIT EINWEG-ARMATUR STREAM (CHR / BLACK)

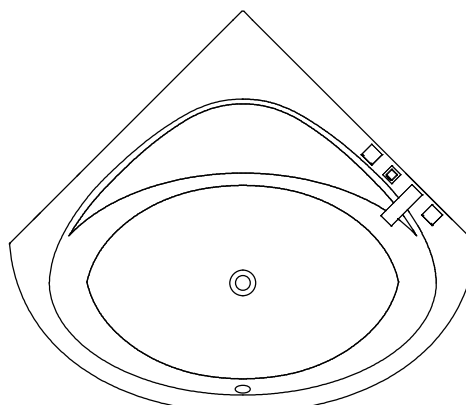
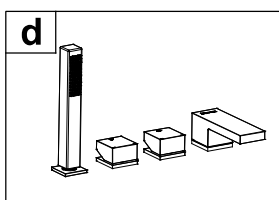

V NAVEDENO KOPALNO KAD NE VGRAJUJEMO MASAŽNIH SISTEMOV

U NAVEDENU KUPAONSKU KADU NE UGRAĐUJEMO MASAŽNIH SISTEMOV

WE DO NOT INSTALL MASSAGE SYSTEMS IN THE GIVEN BATHTUB

IN DER ANGEGEBENEN BADEWANNE WERDEN MASSAGESYSTEMEN NICHT EINGEBAUT

OPCIJE OPCIE OPTIONS MÖGLICHKEITEN

- POLOŽAJ OBLOG NA KOPALNI KADI
- POZICIJA OBLOGE NA KADI
- PANEL POSITIONS ON THE BATH
- POSITION DER SHÜRZE FÜR BADEWANNE

